

THINDR

1747.AS.7/..
opbouw plafondverlichting

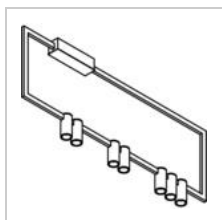

Lichtdistributie

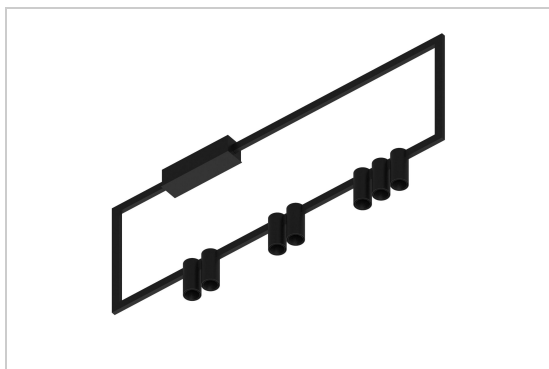
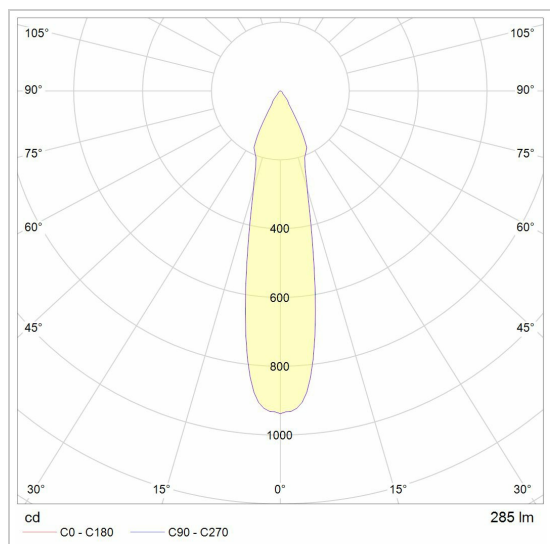

Project _____
Type _____
Nota _____
Aantal _____
Datum _____

LED

Lamptype	Led
Aantal	7
Vermogen	3,8W
Stroom	350mA
Kelvin	2700K 3000K
Lumen	467
CRI	80

Fysisch

Type gebruik	Interieur
Type bevestiging	Plafond
Afmetingen armatuur	900x45x380 mm
frame	L900xB300 mm
IP-beschermingsgraad	IP20

Elektrisch

Aansluitspanning	~230V
Armatuurklasse	I
LED driver	Inbegrepen
Dimbaar	Led C
Vervangbaarheid voorschakelapparatuur	Vervangbare voorschakelapparatuur door een installateur
Vervangbaarheid lichtbron	Vervangbare lichtbron (enkel LED) door installateur
Energie efficiëntie	E

Project _____

Type _____

Nota _____

Aantal _____





Datum _____

THINDR

1747.AS.7/..

opbouw plafondverlichting

Kleuren

	116	wit - goud	1747.AS.7.116.WW NW
	1M	wit textuur	1747.AS.7.1M.WW NW
	216	zwart - goud	1747.AS.7.216.WW NW
	29	zwart - goud in	1747.AS.7.29.WW NW
	2M	zwart textuur	1747.AS.7.2M.WW NW
	47	zwart - wit in	1747.AS.7.47.WW NW
	49	wit - goud in	1747.AS.7.49.WW NW